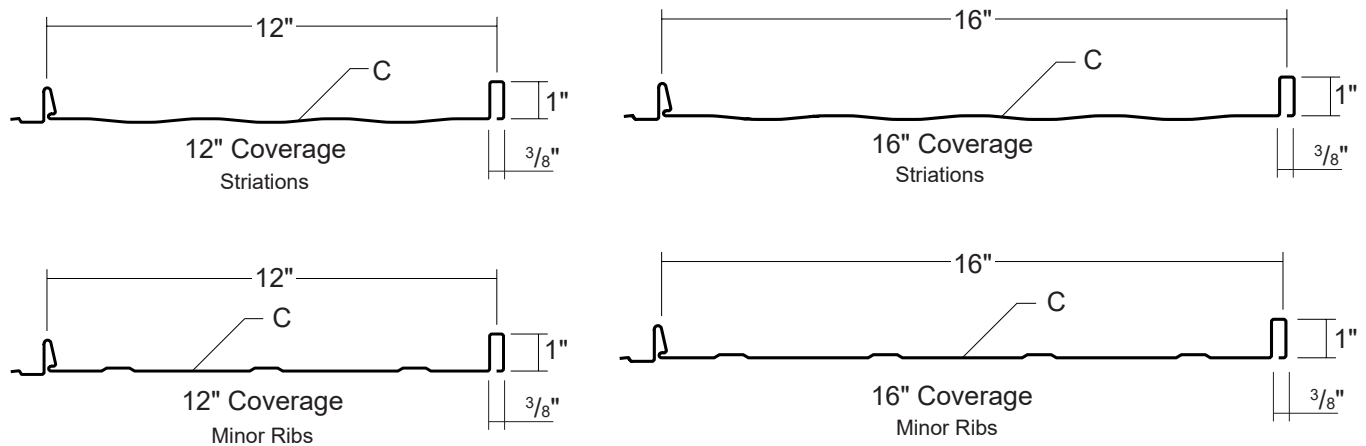

IMAGE II



ARCHITECTURAL
RESIDENTIAL
PANEL

CONCEALED
FASTENED

12" OR 16"
COVERAGE

MINIMUM
SLOPE
3:12

SOLID WOOD
SUBSTRATE

PANEL OVERVIEW

- ▶ Finishes: MS Colorfast45[®] and Acrylic-Coated Galvalume[®]
- ▶ Corrosion Protection: AZ55 per ASTM A 792 for unpainted Galvalume[®]
AZ50 per ASTM A 792 for painted Galvalume[®]
G90 per ASTM A 653 for Galvanized
- ▶ Gauges: 26 ga standard; 24 ga optional
- ▶ 12" or 16" panel coverage, 1" rib height
- ▶ Panel Length: Minimum: 5'; Maximum: 30' recommended
- ▶ Architectural, concealed direct fastened, integral standing rib roof system
- ▶ Minimum roof slope: 3:12
- ▶ Applies over plywood with minimum 30# felt underlayment

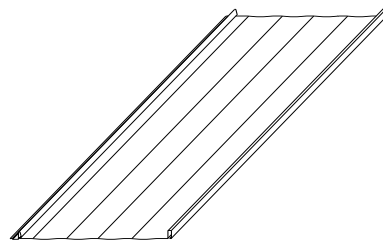

With Striations

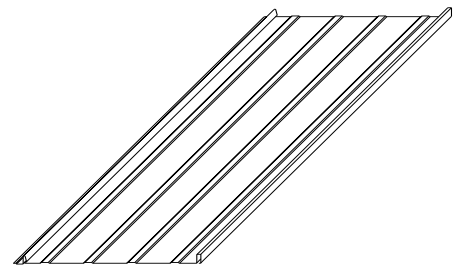

With Minor Ribs

TESTING AND APPROVALS

- ▶ UL 2218 Impact Resistance - Class 4
- ▶ UL 790 Fire Resistance Rating - Class A, per building code
- ▶ UL 263 Fire Resistance Rating - per assembly
- ▶ UL 580 Uplift Resistance - Class 90 Construction: #529
- ▶ Texas Windstorm - Evaluation RC-162 and RC-399
- ▶ 2017 FBC Approvals - FL11560.4, FL11560.5 and FL14645.12
- ▶ Miami-Dade County, Florida NOA 18-0830.03 expires 8/8/2023
- ▶ ICC Evaluation Report - ESR-2385

ATTACHMENT DETAIL

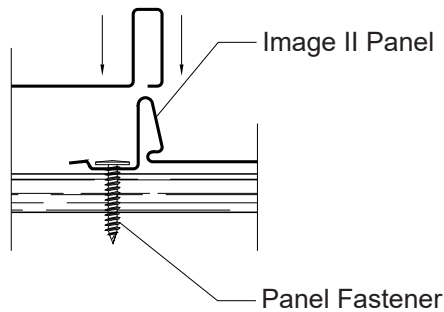

FASTENING PATTERN

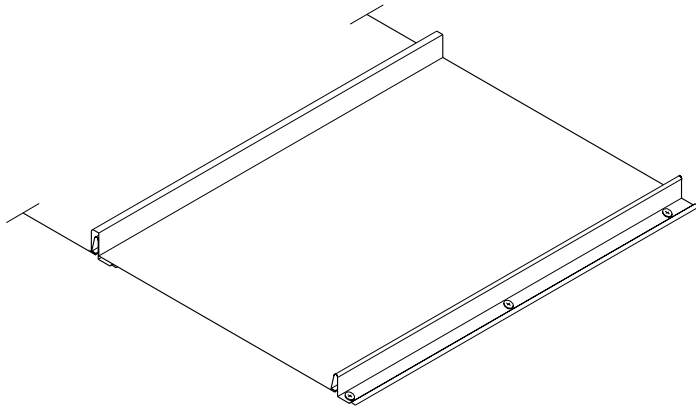

FASTENER INFORMATION

Overdriven fasteners will cause panel distortions.

Fasteners should extend 1/2" or more past the inside face of the support material.

Thick panels (ex. 18 ga) or supports (ex. 1/2" steel) may require predrilling of holes for screws.

Panel Fastener:

#10-16 Pancake Head Wood Screw
or
#8-15 Truss Head Wood Screw

Concealed End Fastener:

#10-16 Pancake Head Wood Screw
or
#8-15 Truss Head Wood Screw

Exposed End Fastener:

#10-14 XL Wood Screw

Trim Fastener:

1/4"-14 x 7/8" XL Stitch Screw
or
1/8" x 3/16" Pop Rivet

SECTION PROPERTIES

ALLOWABLE UNIFORM LOADS, psf For various fastener spacings

Ga	Width in	Yield ksi	Weight psf	Top In Compression		Bottom In Compression		Outward Load			
				I _{xx} in ⁴ /ft	S _{xx} in ³ /ft	I _{xx} in ⁴ /ft	S _{xx} in ³ /ft	0.5'	1'	1.5'	2'
26	16	50	0.92	0.0165	0.0174	0.0165	0.0177	103	96	90	84
24	16	50	1.19	0.0210	0.0226	0.0210	0.0226	103	96	90	84

- Theoretical section properties have been calculated per AISI 2012 'North American Specification for the Design of Cold-Formed Steel Structural Members'. I_{xx} and S_{xx} are effective section properties for deflection and bending.
- Allowable load is calculated in accordance with AISI 2012 specifications considering bending, shear, combined bending and shear, deflection and UL 580 uplift test using #10-12 Pancake Wood Screws into 5/8" plywood. Allowable load considers the 3 or more equal spans condition. Allowable load does not address web crippling, or support material. Panel weight is not considered.
- Deflection consideration is limited by a maximum deflection ratio of L/180 of span.
- Allowable loads do not include a 1/3 stress increase for wind.